

DH-IPC-HUM8241-E1-L4

2MP Covert Pinhole WizMind Network Camera-KIT



Launched by Dahua Technology, Dahua WizMind is a full portfolio of solutions composed of project-oriented products including IPC, NVR, PTZ, XVR, Thermal and software platform which adopts industry-leading deep learning algorithms. Focusing on customer's requirements, WizMind provides precise, reliable and comprehensive AI solutions for verticals.

Series Overview

With deep learning algorithm, the separate pinhole camera supports functions such as perimeter protection and face recognition. Working with different types of lenses, the camera is widely applied to hidden or small scenes such as banks and advertising screens, meeting requirements in different installation scenes.

Functions

Smart H.265+ & Smart H.264+

With advanced scene-adaptive rate control algorithm, Dahua smart encoding technology realizes the higher encoding efficiency than H.265 and H.264, provides high-quality video, and reduces the cost of storage and transmission.

WDR

With advanced Wide Dynamic Range (WDR) technology, Dahua network camera provides clear details in the environment of strong brightness contrast. The bright and dark area can get clear video even in high brightness environment or with backlight shadow.

Perimeter Protection

With deep learning algorithm, Dahua Perimeter Protection technology can recognize human and vehicle accurately. In restricted area (such as pedestrian area and vehicle area), the false alarms of intelligent

- Starlight 2MP 1/2.8" CMOS image sensor, excellent low luminance performance and high definition of images.
- Outputs max. 2MP (1920 × 1080)@25/30 fps.
- H.265 codec, high compression ratio, and ultra-low bit rate.
- ROI, SMART H.264 +/H.265+, flexible coding, applicable to various bandwidth and storage environments.
- Rotation mode, WDR, 3D NR, HLC, BLC, digital watermarking, applicable to various monitoring scenes.
- Intelligent detection: Intrusion, tripwire, fast moving (the three functions support the classification and accurate detection of vehicle and human); abandoned object, missing object, loitering detection, people gathering, and face detection.
- Abnormality detection: Motion detection, privacy masking, scene changing, audio detection, no SD card, SD card space warning, SD card error, network disconnection, IP conflict, illegal access, and voltage detection.
- Alarm: 2 in, 2 out; audio: 1 in, 1 out; RS-232; max. 256 G Micro SD card.
- 12V DC/PoE power supply facilitates installation.
- Power on after connecting the lens to the back-end device; otherwise the device might be damaged.



detection based on target type (such as tripwire, intrusion, fast moving, parking detection, loitering detection and gathering detection) are largely reduced.

Face Detection

Dahua Face Detection technology can detect the face in the image. With deep learning algorithm, the technology supports detecting, tracking, capturing and selecting the best face image, and then outputs face snapshot.

Face Attributes

With deep learning algorithm, the network camera can recognize face attributes, such as gender, age, expression, glasses, mouth mask, and beard.

Cyber Security

Dahua network cameras employ a series of security technologies, including security authentication and authorization, access control protocols, trusted protection, encrypted transmission and encrypted storage. These technologies improve the camera's defense against external cyber threats and prevent malicious programs from compromising the device.

Technical Specification

Camera	
Image Sensor	1/2.8" CMOS
Max. Resolution	1920 (H) × 1080 (V)
ROM	128 MB
RAM	512 MB
Scanning System	Progressive
Electronic Shutter Speed	Auto/Manual 1/3 s–1/100,000 s
Min. Illumination	0.005 Lux@F2.0 (Color,30 IRE) 0.0005 Lux@F2.0 (B/W,30 IRE)
S/N Ratio	> 56 dB

Lens					
Lens Type	Fixed-focal				
Lens Mount	M12				
Focal Length	2.8 mm				
Max. Aperture	2.8 mm: F2.0				
Field of View	Horizontal: 105°; Vertical: 58°; Diagonal: 118°				
Iris Control	Fixed				
Close Focus Distance	0.5 m				
DORI Distance	Len	Detect	Observe	Recognize	Identify
	IPC-HUM8241-L4	42.1 m (138.1 ft)	16.8 m (55.1 ft)	8.4 m (27.6 ft)	4.2 m (13.8 ft)

Intelligence	
IVS (Perimeter Protection)	Tripwire, intrusion, fast moving (the three functions support the classification and accurate detection of vehicle and human); loitering detection, people gathering, and parking detection
Face Detection	Face detection; track; snapshot; snapshot optimization; optimal face snapshot upload; face enhancement; face exposure; face attribute extraction including 6 attributes (gender, age, glasses, expressions, mask and beard) and 8 expressions (anger, calm, happiness, sadness, disgust, surprise, confusion and fear); face snapshot set as face or one-inch photo; 3 snapshot strategies (real-time snapshot, optimization snapshot, and quality priority); face angle filter; optimization time setting
Smart Search	Work together with Smart NVR to perform refine intelligent search, event extraction and merging to event videos

Video	
Video Compression	H.265; H.264; H.264H; H.264B; MJPEG (only supported by the sub stream)
Smart Codec	Smart H.265+ Smart H.264+
Video Frame Rate	Main stream: 1920 × 1080 @25/30 fps Sub stream: 704 × 576 @25 fps; 704 × 480 @30 fps Third stream: 1920 × 1080 @25/30 fps
Stream Capability	3 streams
Resolution	1080p (1920 × 1080); 1.3M (1280 × 960); 720p (1280 × 720); D1 (704 × 576/704 × 480); VGA (640 × 480); CIF (352 × 288/352 × 240)

Bit Rate Control	CBR/VBR
Video Bit Rate	H.264: 3 kbps–20480 kbps H.265: 3 kbps–20480 kbps
Day/Night	Color/B/W
BLC	Yes
HLC	Yes
WDR	120 dB
Scene Self-adaptation (SSA)	Yes
White Balance	Auto; natural; street lamp; outdoor; manual; regional custom
Gain Control	Manual; auto
Noise Reduction	3D NR
Motion Detection	OFF/ON (4 areas, rectangular)
Region of Interest (RoI)	Yes (4 areas)
Defog	Yes
Image Rotation	0°/90°/180°/270° (support 90°/270° with 1080p resolution and lower)
Mirror	Yes
Privacy Masking	4 areas

Audio	
Audio Compression	G.711a; G.711Mu; PCM; G.726; G.723

Alarm	
Alarm Event	No SD card, SD card full, SD card error, network disconnection, IP conflict, illegal access, motion detection, video tampering, tripwire, intrusion, fast moving, missing object, abandoned object, parking detection, loitering detection, people gathering; scene changing, audio detection, voltage detection, external alarm, face detection, and security exception.

Network	
Network Port	RJ-45 (10/100 Base-T)
SDK and API	Yes
Network Protocol	IPv4; IPv6; HTTP; TCP; UDP; ARP; RTP; RTSP; RTCP; RTMP; SMTP; FTP; SFTP; DHCP; DNS; DDNS; QoS; UPnP; NTP; Multicast; ICMP; IGMP; NFS; SAMBA; PPPoE; SNMP
Interoperability	ONVIF (Profile S/Profile G/Profile T); CGI; P2P; Milestone; Genetec
User/Host	20 (Total bandwidth: 64 M)
Storage	FTP; SFTP; Micro SD card (Support max. 256 G); NAS
Browser	IE: IE8, IE9, and IE11 Chrome Firefox
Management Software	Smart PSS; DSS; DMSS
Mobile Client	IOS; Android
Cyber Security	Video encryption; Firmware encryption; Configuration encryption; Digest; WSSE; Account lockout; Security logs; IP/MAC filtering; Generation and importing of X.509 certification; syslog; HTTPS; 802.1x; Trusted boot; Trusted execution; Trusted upgrade

Certification

Certifications	CE-LVD:EN62368-1; CE-EMC:Electromagnetic Compatibility Directive 2014/30/EU; FCC:47 CFR FCC Part 15, Subpart B
----------------	--

Port

Audio Input	1 channel (3.5 mm JACK port)
Audio Output	1 channel (3.5 mm JACK port)
Alarm Input	2 channels in: 5 mA 3V–5V DC
Alarm Output	2 channels out: 1,000 mA 30V DC/500 mA 50V DC

Power

Power Supply	12V DC/PoE (802.3af)
Power Consumption	Basic: 2.3W (12V DC); 2.8W (PoE) Max. (Intelligence + WDR): 3.7W (12V DC); 4.5W (PoE)

Environment

Operating Temperature	-40°C to +60°C (-40°F to 140°F)
Operating Humidity	≤95%
Storage Temperature	-40°C to +60°C (-40°F to 140°F)

Structure

Casing	Metal
Product Dimensions	E1: 110 mm × 83 mm × 24 mm (4.33" × 3.27" × 0.94") L4: 35 mm × 35 mm × 26.7 mm (1.38" × 1.38" × 1.05")
Net Weight	210 g (0.5 lb)
Gross Weight	376 g (0.8 lb)

Ordering Information

Type	Model	Description
Main Box	DH-IPC-HUM8241-E1	2MP Covert Pinhole WizMind Network Camera-Main Box
Len	IPC-HUM8241-L4	2MP Covert Pinhole WizMind Network Camera-Len Unit

Installation

Junction Mount	Plane Mount	Ceiling Mount

Dimensions (mm[inch])

DH-IPC-HUM8241-E1

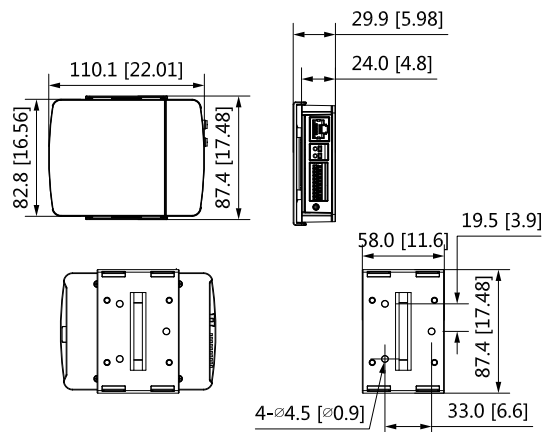

IPC-HUM8241-L4

